neddoffice

MİMARLIK SAN. TİC. LTD. ŞTİ.

SİSTEM VE REFERANS SUNUMU
Presentation of Systems and Referances

- Ürünlerimiz
- neddoffice Teknik Bilgi Dokümanları
- neddoffice Akustik TSE Raporları & ISO 9001
- Çalışma Ortaklarımız
- Tedarikçilerimiz
- Ham Madde Kalite Belgeleri
- LEED Sertifikaları
- Referanslar
- Projelerimiz
- Neden Biz?

- Products
- neddoffice Technical Information Documents
- neddoffice Acoustic TSE Certificates & ISO 9001
- Working Partners
- Suppliers
- Raw Materials' Quality Certificates
- LEED Certificates
- Referances
- Projects
- Why Us?

ÜRÜNLERİMİZ

PRODUCTS

trenta

Camcama sistem serileri Glass to glass system series

Dikey kayıtları olmayan tek ve çift cam seçenekleriyle daha şeffaf ofisler,
Çift cam arası motorlu jaluzi ve cam filmiyle dilediğiniz kadar gizlilik.
trenta; yeni nesil ofislerin trendi...

More transparent and quieter offices with single and double glaze options without vertical profile.

*Privacy to the extent you would desire with motor operated blinds installed between double glazing and window films...
trenta; Trend of new offices...*



Çift camcama sistem serileri
Double glass to glass system series



Tek camcama sistem serileri
Glass to glass system series

neddoffice®
the final touch



trenta

Teknik detaylar
Technical details



Çift camcama sistem serisi
Double glass to glass system series



Duvar başlangıç sistemi
Initial system for double glass system



Sürgülü cam kapı kolu
Cylindrical pull handle for sliding glass door, non-locking



Ayarlanabilir alt cam tutucu
Adjustable bottom glass retainer



Dikey barelli cam kapı kolu
Vertical cylinder glass door handle



Standart cam kapı kolu
Standard glass door handle



Tam boy cam kanat
Swinging glass door - full height

Teknik Detay Technical Details



Standart cam kapı menteşesi
Standard swinging glass door hinge



Tek camcama sistem serisi
Single glass to glass system series



Kayar kapı sistemi
Sliding door system



Teknik bağlantı modülü alüminyum.
Aluminum technical fitting module.



Polikarbon cam birleşim detayı
Polycarbonate profile - glass fitting



Ahşap kapı kolu
Wooden door handle



Kart okuyuculu standart kapı kolu.
Standard lever handle with card reader



Sürgülü camkapı kolu kilitli
Cylindrical pull handle for sliding glass door, top-locking

trenta

	trenta th 10mm Tempered Glass	trenta th 5+5mm Standard Laminated Glass	trenta th 5+5mm Acoustic Laminated Glass	trenta exc 8+8mm Acoustic Laminated Glass
Dimensions	Dependent on construction			
System Thickness	25 X 32 mm	25 X 32 mm	25 X 32 mm	49x50 mm
Widths	Preferred grid axis 300/600/900/1000 mm			All intermediate dimensions - up to 1200 mm
Heights	2500 / 2700 / 3000 mm			All intermediate dimensions - up to 3200 mm
Weights	27 Kg / m ²	27 Kg / m ²	27 Kg / m ²	43 Kg / m ²
Joints	2 mm - in verticals between glass-door / glass-solid panel / solid-solid / solid - door			
Horizontal Glass Connection	Without Aluminium Profile - Special clear beading			
Sound Insulation	28-31 dB	29-32 dB	37 dB	42-45 dB
Electric Base	120 mm aluminium relocatable electric profile for both vertical and horizontal usage			
Tolerance	In Height and width + - 10 mm			
Glass	Standart 1 x 10 mm Tempered Clear Glass		trenta exc 1 X 8+8 mm Laminated Glass	
Door and Glazing frames	Aluminium , E6/EV1 anodised , or powder coated Standard K7 Rail Boards			
Door Leaves	Various according to design, 40 or 66 mm thickness HPL, veneered door leaves / Glazed Doors with/without frame		Glazed Door Wings without frames 8+8 mm Clear Tempered Laminated	
Door ironmongery	2/3 stainless steel Aluminium hinges. Door handle and lock Hoppe HCS		2/3 stainless steel hinges. Door handle and lock Dorma Junior	
Corner Posts	90 Degree or Multi angled Aluminium Posts		glass - glass	

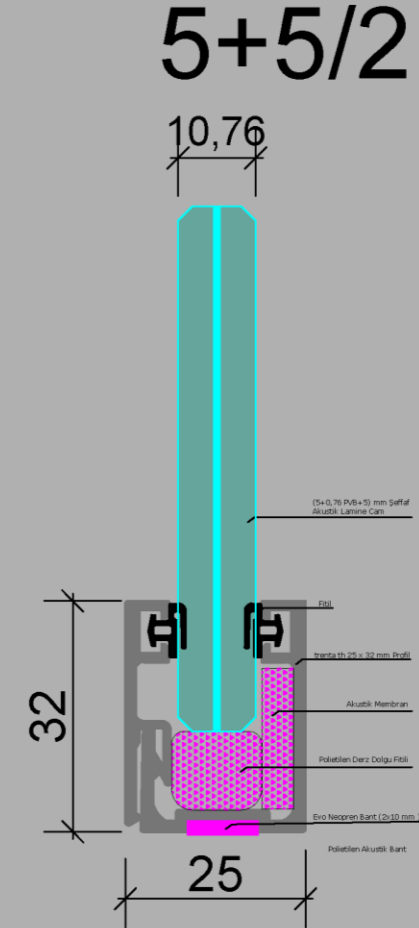

ÜRÜNLERİMİZ / trenta th

PRODUCTS

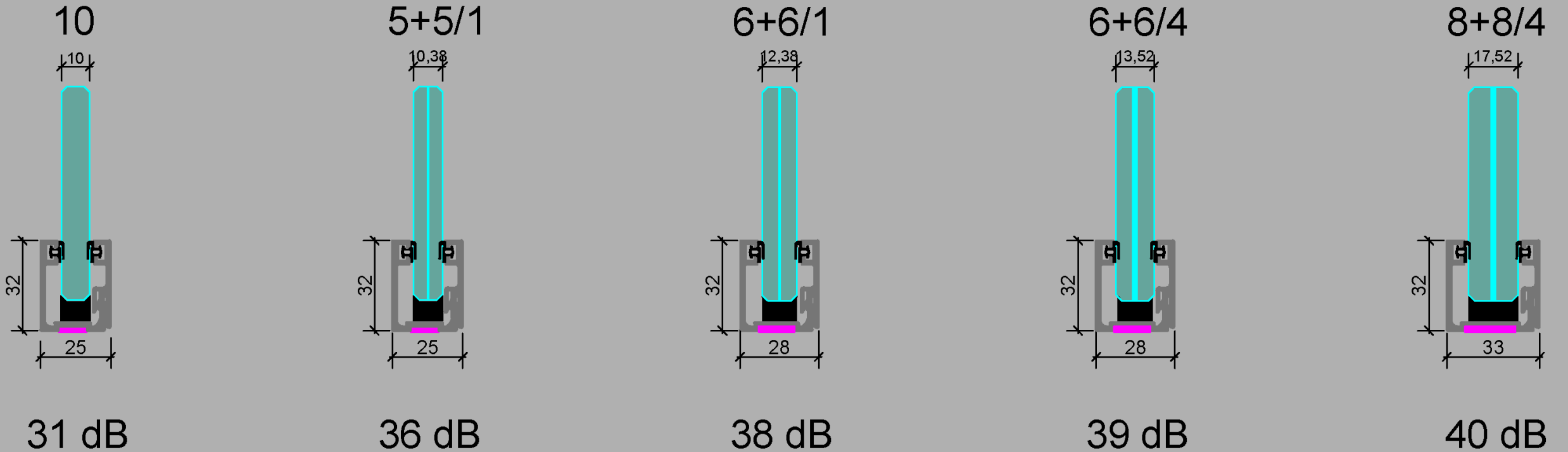

ÜRÜNLERİMİZ / trenta th

PRODUCTS

neddoffice®
the final touch

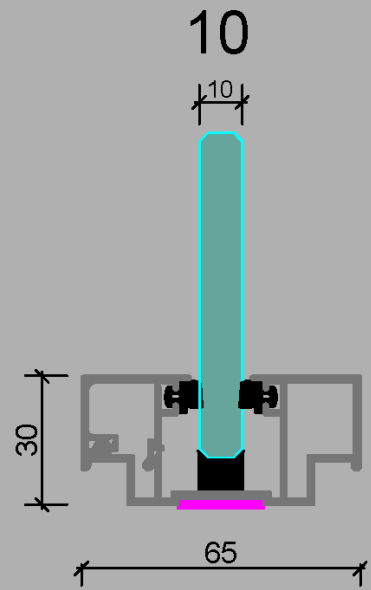

31 dB

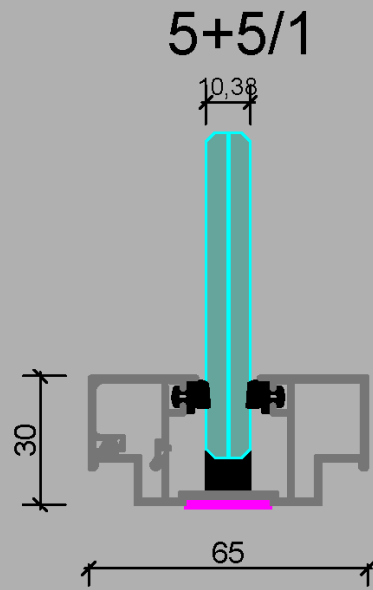

36 dB

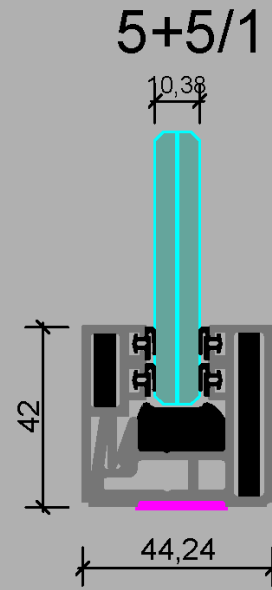

36 dB

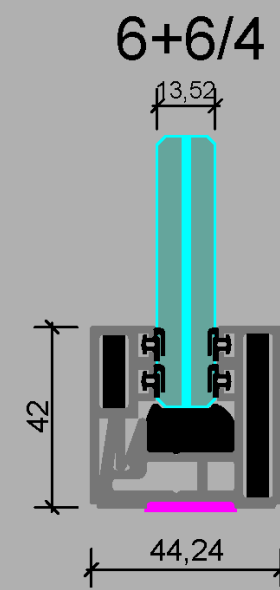

39 dB

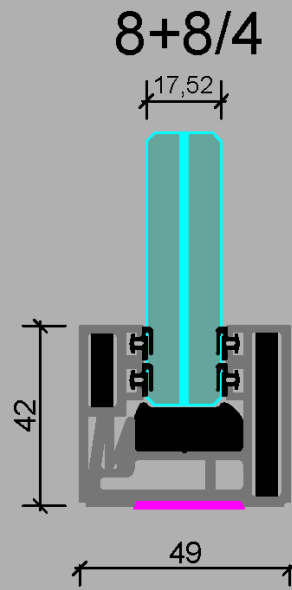

40 dB

GALERI / trenta th

GALLERY



trenta dg

	trenta dg 2x10mm Tempered Glass	trenta dg 1x5+5mm Standard Laminated Glass 1x10mm Tempered Glass	trenta dg 1x5+5mm Acoustic Laminated Glass 1x5+5mm Acoustic Laminated Glass
Dimensions	Dependent on construction		
System Thickness	65 X 32 mm	65 X 32 mm	65 X 32 mm
Widths	Preferred grid axis 300/600/900/1000 mm		
Heights	2500 / 2700 / 3000 mm		
Weights	53 Kg / m ²	53 Kg / m ²	53 Kg / m ²
Joints	2 mm - in verticals between glass-door / glass-solid panel / solid-sollid / solid - door		
Horizontal Glass Connection	Without Aluminium Profile - Special clear beading		
Sound Insulation	36-38 dB	38-40 dB	42 dB
Electric Base	120 mm aluminium relocatable electric profile for both vertical and horizontal usage		
Tolerance	In Height and width + - 10 mm		
Glass	Standart 2 x 10 mm Tempered Clear Glass		
Door and Glazing frames	Aluminium , E6/EV1 anodised , or powder coated Standard K7 Ral Boards		
Door Leaves	Various according to design, 40 or 66 mm thickness HPL, veneered door leaves / Glazed Doors with/without frame		
Door ironmongery	2/3 stainless steel Aluminium hinges. Door handle and lock Hoppe HCS		
Corner Posts	90 Degree or Multi angled Aluminium Posts		

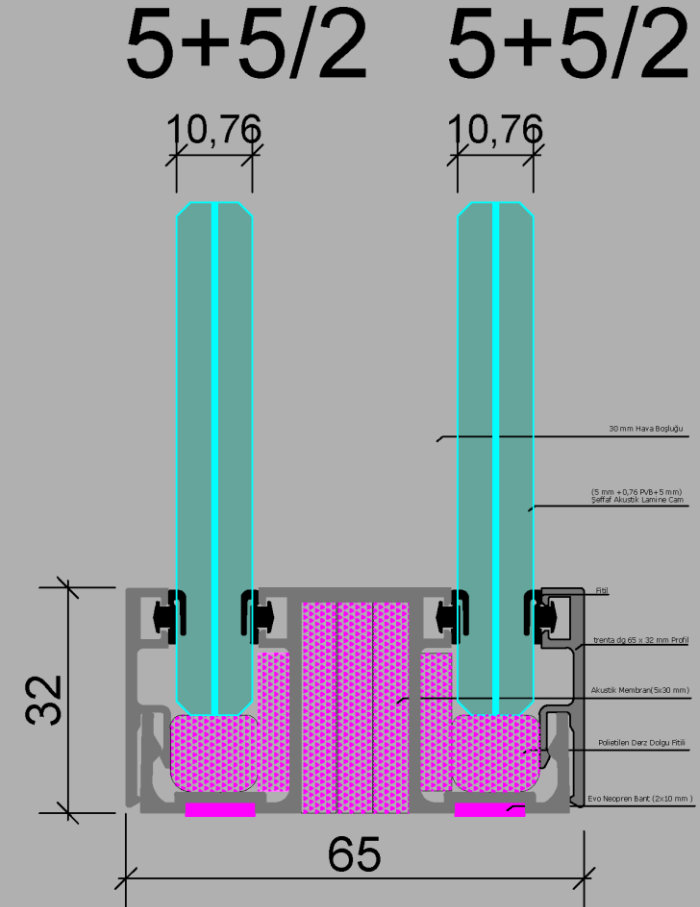

42 dB

ÜRÜNLERİMİZ / trenta dq

PRODUCTS

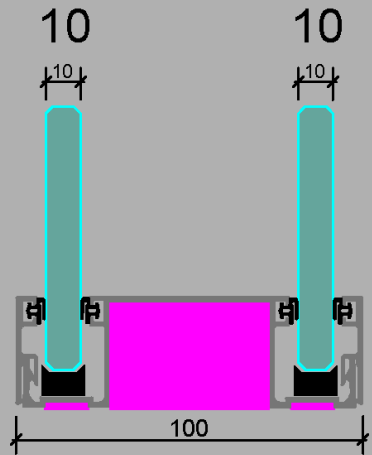

38 dB

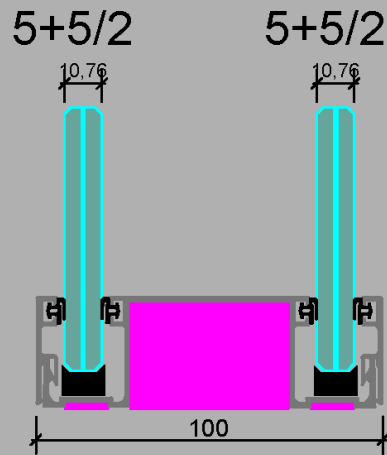

42 dB

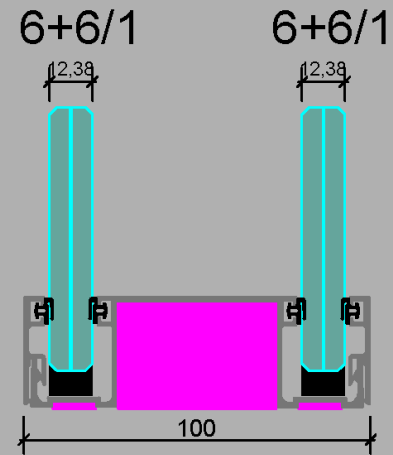

49 dB

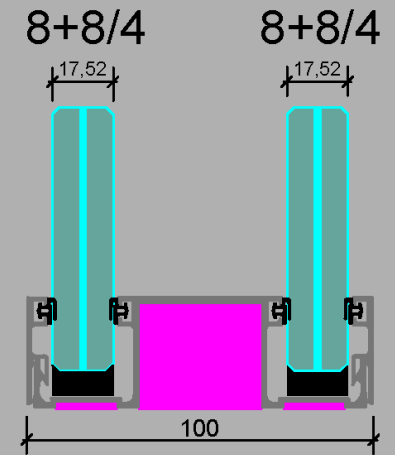

52 dB

PRODUCTS

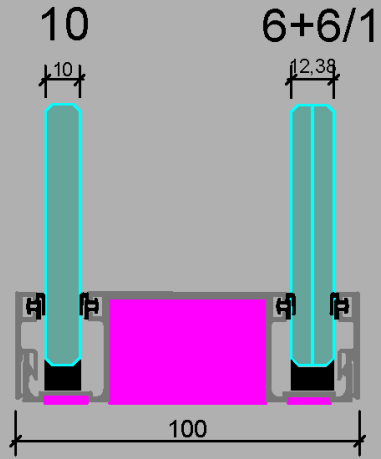

39 dB

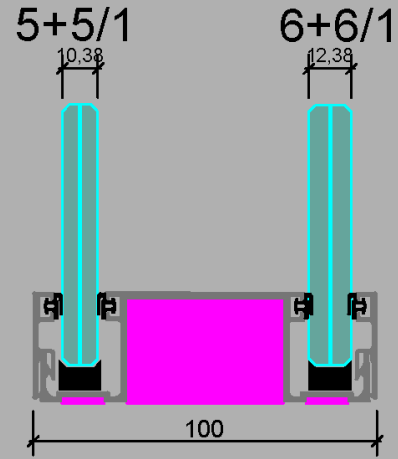

43 dB

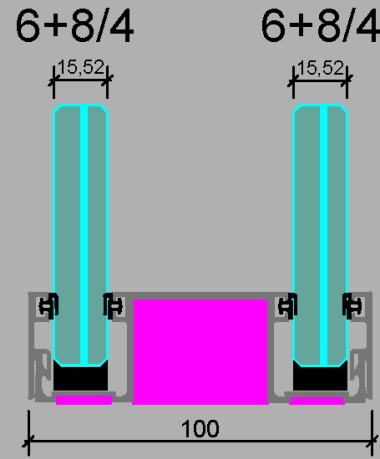

50 dB

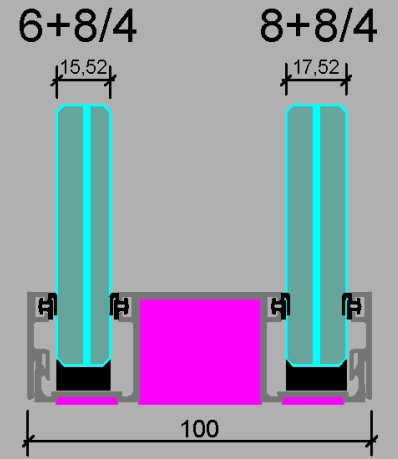

52 dB

GALERI / trenta dq

GALLERY

neddoffice®
the final touch

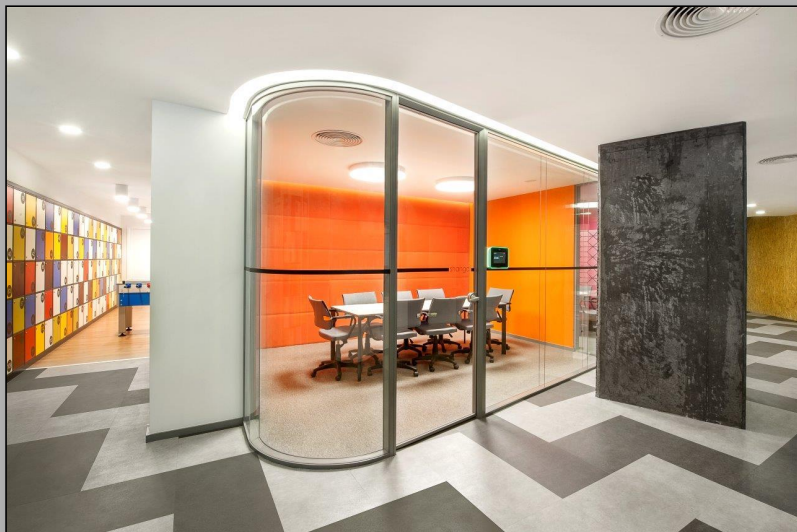

ÜRÜNLERİMİZ

PRODUCTS

quattro

Demontable sistem serileri Demontable system series.

Yatay ve düşey çerçeveli camlar ile akustik, ahşap ve film kaplı yüzeylerin oluşturduğu geleneksel ofisler. Çift cam arası manuel jaluzi ve cam filmi ile dilediğiniz kadar gizlilik. quattro; geleneksel ofislerin prestiji.

Traditional offices created by vertical and horizontal framed glass and acoustic surfaces coated with wood and film.

Privacy to the extent you would desire with manually operated blinds installed between double glazing and window film.

quattro; Prestige offered by traditional office



neddoffice®
the final touch

quattro
Teknik detaylar
Technical details



Çerçeve birleşim detayı
Frame fitting details



Teknik bağlantı modülü
Technical fitting module



Teleskopik çerçeveli
malamin kapı
Telescopish framed wooden door



Tek cam çerçeve
Framed single glass



Standart kapı kolu
Standard handle for wood door



Çok açılı dönüş sistemi
Multi-angle rotation system



Köşe 90° dönüş sistemi
90 degree corner system

Teknik Detay Technical Details



Sonlandırma profili
Finishing profile



Çift cam arası manuel
jaluzi sistemi.
Manual blinds between double glass



Üç yönlü dönüş sistemi
Three-way rotation system



Teleskopik çerçeveli cam kapı
Telescopish framed glass door



Standart cam kapı menteşesi
Standard swinging glass door hinge



Çift cam duvar başlangıç
sistemi.
Initial module for double glass frame



Standart cam kapı kolu
Standard glass door handle











quattro iç dikme sistemi
quattro internal structure

GALERI / quattro

GALLERY



 TÜRK STANDARDLARI ENSTİTÜSÜ DENEY ve KALİBRASYON MERKEZİ BAŞKANLIĞI YAPI MALZEMELERİ YANGIN VE AKUSTİK LABORATUVAR MÜDÜRLÜĞÜ TURKISH STANDARDS INSTITUTION HEADSHIP OF TSE TEST and CALIBRATION CENTER CONSTRUCTION MATERIALS FIRE AND ACOUSTICS LABORATORY AYDINLI MAH. ULUS SOK. NO:71 TUZLA-İSTANBUL Tel: +902165000561 Faks: e-mail: yabim@tse.org.tr www.tse.org.tr		  TSE TS EN ISO/IEC 17025 AB-0001-T AB-0001-T 4524 02-22		
MUAYENE VE DENEY RAPORU <i>TEST REPORT</i>				
Deneysel Talep Eden/Firma : (Adı, Adresi, Şehir vb.) Requesting/Customer (Name, Address, City etc.)	NEDDOFFICE MİMARLIK SANAYİ VE TİCARET LİMİTED ŞİRKETİ CUMHURİYET MAH. YENİ YOL 1 SK. BOMONTI BUSINESS CENTER Dış Kapı No:51 İç Kapı No:8 ŞİŞLİ İSTANBUL/İSTANBUL			
Deneysel Talep Tarihi / No : Order Date/No.	20.01.2022 / 2022-11547			
Numunenin Tanımı : (Cins, Marka, Sınıf, Tip, Tür, Model vb.) Sample Description (Type, Mark, Class, Model etc.)	2022-010148 , trenta th 5 25 x 32 mm Single glass to glass Office partition / (5 mm + 0.76 PVB + 5 mm) Partition system constituted by transparent Acoustic laminated glass , - , - , - , - , - , - , 1.00 metrekafe			
Numune Kabul Tarihi : Test Item Receipt Date	01.02.2022			
Deneyleerin Yapıldığı Tarihi : Date of Test	01.02.2022 / 10.02.2022			
Uygulanan Standart Metot :	, TS EN ISO 10140-2/Acoustics - Laboratory measurement of sound insulation of building elements - Part 2: Measurement of airborne sound insulation, TS EN ISO 717-1: 2021/Acoustics - Rating of sound insulation in buildings and of building elements - Part 1: Airborne sound insulation			
Raporun Sayfa Sayısı : Number of pages of the report	11			
Deneysel Sonucu :	-			
Açıklamalar :	"Bu rapor 08-21 tarih ve 624541 sayılı Türkçe raporun çevirisi olup, söz konusu rapordaki sonuçlar esas alınmıştır. Yeni bir deney yapılmamıştır." "This report is the translation of the test report with 08-21 date and 624541 report number and the results in this report based on the results in the previous report in question. New test has not been conducted."			
Yukarıda tanımlanan numune için laboratuvarımızda yapılan muayene ve deneylerden elde edilen sonuçlar müteakip sayfalarda verilmiştir. The testing and/or measurement results are given on the following pages which are part of this report.				
Deneysel laboratuvarları olarak faaliyet gösteren TSE Deneysel ve Kalibrasyon Merkezi Başkanlığı Deneysel Laboratuvarları TÜRKAK'tan AB-0001-T ile TS EN ISO/IEC 17025:2012 standardına göre akredite edilmiştir. TSE Headship of Test and Calibration Center Testing Laboratories accredited by TÜRKAK under registration number AB-0001-T for TS EN ISO/IEC 17025:2012 as test laboratory. TÜRKAK deneysel raporlarının tanınması konusunda Avrupa Akreditasyon Birliği (EA) ile Çok Taraflı Anlaşma ve Uluslararası Laboratuvar Akreditasyon Birliği (ILAC) ile karşılıklı tanıma anlaşması imzalanmıştır. TÜRKAK is a signatory to the European co-operation for Accreditation (EA) Multilateral Agreement (MLA) and to the International Laboratory Accreditation Cooperation (ILAC) Mutual Recognition Arrangement (MRA) for the recognition of test reports. Deneysel ve/veya ölçüm sonuçları, genişletilmiş ölçüm belirsizlikleri (olması halinde) ve deneysel metodları bu raporun tamamlayıcı kısmı olan takip eden sayfalarda verilmiştir. The test and/or measurement results, the uncertainties (if applicable) with confidence probability and test methods are given on the following pages which are part of this report.				
Mühür Seal	Tarih Date	Deneysel Sorumlusu Person in charge of test	Kontrol Eden Reviewer	Onaylayan Head of Laboratory
	10.02.2022	MEHMET HÜDAİ BAŞTÜRK	HALİL ALPER YILDIRIM	SENCER GÜVEN
Bu rapor, hazırlayan laboratuvarın yazılı izni olmadan kısmen kopyalanıp çoğaltılamaz. İnzansız ve karekoduz raporlar geçersizdir. Bu rapor, sadece deneysel yapılan numune için geçerlidir ve "Ürün Belgesi" yerine geçmez. This test report shall not be reproduced other than in full except with the written permission of the laboratory. Test reports without signature and seal are not valid. This test report represents only tested samples, and shall not be used as Product Certificate. Bu doküman elektronik ortamda imzalanmıştır. Doğrulama adresi: https://basvuru.tse.org.tr/uyeQRKodDogrulama?code=AB07F7				

 TÜRK STANDARDLARI ENSTİTÜSÜ DENEY ve KALİBRASYON MERKEZİ BAŞKANLIĞI YAPI MALZEMELERİ YANGIN VE AKUSTİK LABORATUVAR MÜDÜRLÜĞÜ TURKISH STANDARDS INSTITUTION HEADSHIP OF TSE TEST and CALIBRATION CENTER CONSTRUCTION MATERIALS FIRE AND ACOUSTICS LABORATORY AYDINLI MAH. ULUS SOK. NO:71 TUZLA-İSTANBUL Tel: +902165000561 Faks: e-mail: yabim@tse.org.tr www.tse.org.tr		  TSE TS EN ISO/IEC 17025 AB-0001-T AB-0001-T 4176 02-22		
MUAYENE VE DENEY RAPORU <i>TEST REPORT</i>				
Deneysel Talep Eden/Firma : (Adı, Adresi, Şehir vb.) Requesting/Customer (Name, Address, City etc.)	NEDDOFFICE MİMARLIK SANAYİ VE TİCARET LİMİTED ŞİRKETİ CUMHURİYET MAH. YENİ YOL 1 SK. BOMONTI BUSINESS CENTER Dış Kapı No:51 İç Kapı No:8 ŞİŞLİ İSTANBUL/İSTANBUL			
Deneysel Talep Tarihi / No : Order Date/No.	20.01.2022 / 2022-11547			
Numunenin Tanımı : (Cins, Marka, Sınıf, Tip, Tür, Model vb.) Sample Description (Type, Mark, Class, Model etc.)	2022-012580 , trenta dg 5 65 x 32 mm Double glass to glass Office partition system/ (5 mm + 0.76 PVB + 5 mm) + 30 mm air gap + (5 mm + 0.76 PVB + 5 mm) Partition system constituted by transparent acoustic laminated glass , - , - , - , - , - , - , 1.00 1			
Numune Kabul Tarihi : Test Item Receipt Date	01.02.2022			
Deneyleerin Yapıldığı Tarihi : Date of Test	01.02.2022 / 10.02.2022			
Uygulanan Standart Metot :	, TS EN ISO 10140-2/Acoustics - Laboratory measurement of sound insulation of building elements - Part 2: Measurement of airborne sound insulation, TS EN ISO 717-1: 2021/Acoustics - Rating of sound insulation in buildings and of building elements - Part 1: Airborne sound insulation			
Raporun Sayfa Sayısı : Number of pages of the report	11			
Deneysel Sonucu :	-			
Açıklamalar :	"Bu rapor 08-21 tarih ve 624540 sayılı Türkçe raporun çevirisi olup, söz konusu rapordaki sonuçlar esas alınmıştır. Yeni bir deney yapılmamıştır." "This report is the translation of the test report with 08-21 date and 624540 report number and the results in this report based on the results in the previous report in question. New test has not been conducted."			
Yukarıda tanımlanan numune için laboratuvarımızda yapılan muayene ve deneylerden elde edilen sonuçlar müteakip sayfalarda verilmiştir. The testing and/or measurement results are given on the following pages which are part of this report.				
Deneysel laboratuvarları olarak faaliyet gösteren TSE Deneysel ve Kalibrasyon Merkezi Başkanlığı Deneysel Laboratuvarları TÜRKAK'tan AB-0001-T ile TS EN ISO/IEC 17025:2012 standardına göre akredite edilmiştir. TSE Headship of Test and Calibration Center Testing Laboratories accredited by TÜRKAK under registration number AB-0001-T for TS EN ISO/IEC 17025:2012 as test laboratory. TÜRKAK deneysel raporlarının tanınması konusunda Avrupa Akreditasyon Birliği (EA) ile Çok Taraflı Anlaşma ve Uluslararası Laboratuvar Akreditasyon Birliği (ILAC) ile karşılıklı tanıma anlaşması imzalanmıştır. TÜRKAK is a signatory to the European co-operation for Accreditation (EA) Multilateral Agreement (MLA) and to the International Laboratory Accreditation Cooperation (ILAC) Mutual Recognition Arrangement (MRA) for the recognition of test reports. Deneysel ve/veya ölçüm sonuçları, genişletilmiş ölçüm belirsizlikleri (olması halinde) ve deneysel metodları bu raporun tamamlayıcı kısmı olan takip eden sayfalarda verilmiştir. The test and/or measurement results, the uncertainties (if applicable) with confidence probability and test methods are given on the following pages which are part of this report.				
Mühür Seal	Tarih Date	Deneysel Sorumlusu Person in charge of test	Kontrol Eden Reviewer	Onaylayan Head of Laboratory
	10.02.2022	MEHMET HÜDAİ BAŞTÜRK	HALİL ALPER YILDIRIM	SENCER GÜVEN
Bu rapor, hazırlayan laboratuvarın yazılı izni olmadan kısmen kopyalanıp çoğaltılamaz. İnzansız ve karekoduz raporlar geçersizdir. Bu rapor, sadece deneysel yapılan numune için geçerlidir ve "Ürün Belgesi" yerine geçmez. This test report shall not be reproduced other than in full except with the written permission of the laboratory. Test reports without signature and seal are not valid. This test report represents only tested samples, and shall not be used as Product Certificate. Bu doküman elektronik ortamda imzalanmıştır. Doğrulama adresi: https://basvuru.tse.org.tr/uyeQRKodDogrulama?code=782142				

	
CERTIFICATE NEDDOFFICE MİMARLIK SANAYİ VE TİCARET LİMİTED ŞİRKETİ CUMHURİYET MAH. YENİ YOL 1 SOK. BOMONTI BUSINESS CENTER NO:8/51 ŞİŞLİ / İSTANBUL / TÜRKİYE Has been assessed and found to Comply with the Requirements of: Denetlenmiş ve aşağıdaki standardın gerekliliklerine uygunluğu görülmüştür: ISO 9001:2015 The Quality Management System is applicable to: Kalite Yönetim Sistemi: MANUFACTURE AND ASSEMBLY OFFICE GLASS PARTITION AND DOOR SYSTEMS OFİS CAM BÖLME VE KAPI SİSTEMLERİ İMALAT VE MONTAJI Certificate Number: QMS-0102005 Initial Certification Date: 28.10.2021 Belge Numarası: QMS-0102005 İlk Belgelendirme Tarihi: 28.10.2021 Certification Period: 3 Years Certificate Validity Date: 27.10.2022 Belgelendirme Periyodu: 3 Yıl Belge Geçerlilik Tarihi: 27.10.2022   ACCREDITED Management Systems Certification Body MSCB-135 IQR ULUSLARARASI BELGELENDİRME HİZMETLERİ LTD.ŞTİ. Beşevler Mah. Kocayunus Sk. No:3 Arslan Han Plaza K:2 Nilüfer / BURSA Tel.: +90.224.266 00 16 Faks: +90.224.249 41 13 www.iqrcert.com e-posta: info@iqrcert.com	

ÇALIŞMA ORTAKLARIMIZ

WORKING PARTNERS



Anadolu Cam Sanayii A.Ş.

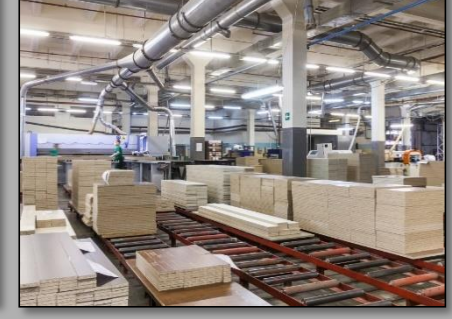

TEDARİKÇİLERİMİZ

SUPPLIERS

neddoffice®
the final touch

HOPPE® 
Der gute Griff.

HÄFELE
FINDING BETTER WAYS

COLCOM

GEZE

dormakaba 

 **SIMONSWERK**

HAM MADDE KALİTE BELGELERİ

QUALITY CERTIFICATES



Certificate of Compliance
Metsim
Saray Döküm ve Madeni Akşam San. Tur. A.Ş.
 ISO14064 ve GHG Protokolü Çıktısı Kapsam 1, 2 ve 3 dahil 2015 Yılı Kurumsal Karbon Ayakizi
 In compliance to ISO14064 ve GHG Protocol including Scope 1, 2 and 3 Corporate Carbon Footprint
1 324 754 t CO₂e
 Dr. Nadia Kara
 Metsimsustainability Consulting
 Certificate No: T20141211

ZAG
Certificate of conformity of the factory production control
 1404 – CPR – 2370
 In accordance with Regulation (EU) No. 305/2011 of the European Parliament and of the Council of 9 March 2011 (the Construction Products Regulation or CPR), this certificate applies to the construction products
Aluminium structural products for construction works extruded profiles, precision profiles
 Issued on the basis of the name or trade mark of
Saray Döküm ve Madeni Akşam Sanayi Turizm AS, Bağlar Mah. Osmangazi Cad. No: 89, 34212 Güneşli İstanbul, Turkey
 and declared in the manufacturing data
Saray Döküm ve Madeni Akşam Sanayi Turizm AS Bağlar Mah. Osmangazi Cad. No: 89, 34212 Güneşli İstanbul, Turkey.
 The certificate attests that all processes concerning the assessment and verification of conformity of performance declared in Annex 2A of the standard
EN 10683:2005
 under system 2+ are applied and that
the factory production control is assessed to be in conformity with the applicable requirements.
 This certificate was first issued on 7. 8. 2014 and will remain valid until 28. 3. 2016 as long as neither the harmonized standard, the normative provision, the AVCP method nor the manufacturing conditions in the plant are modified significantly, unless suspended or withdrawn by the notified body production control certification body.
 More detailed information about the scope of the products is given in the annex to this certificate.
 İstanbul, 26. 5. 2019
 Authorized signatory of the Certification body:
 Mustafa Kemal YILMAZ

NAVIGA CERTIFICATION
SERTİFİKA CERTIFICATE OF REGISTRATION
 Bu sertifika aşağıdaki kuruluşla
 This certificate has been awarded to the company
SARAY DÖKÜM VE MADENİ AKŞAM SANAYİ TURİZM A.Ş.
 Merkez: Yenibosna Mah. Yalçın Kores Cad. No:41/1 Bahçelievler, İSTANBUL
 Fabrika: Vekilliyi Sanayi Bölgesi Saray Bulvarı No:29 Çekirgeköy, TEKİRDAĞ
 Uygulanması olan Bilgi Güvenliği Yönetim Sistemi
 To certify that the implemented Information Security management system complies with
ISO 27001:2013
 Standardına uygunluğu/bunu belirlemek amacıyla aşağıdaki kapsamda değerlendirilmiştir.
 For the activities described below
GÜMRÜK VE DIŞ TİCARET İŞLEMLERİ VE BU İŞLEMLERİN İLİŞKİN LOJİSTİK, DEPOLAMA, MUHAZAR, FİNANŞ VE BİLGİ İŞLERİ FAALİYETLERİNİN BİLGİ GÜVENLÜĞÜ İLE BU FAALİYETLERİ KURUMSAL ARAÇLARLA KULLANILAN GÜVENLİK ÖNLEMLERİ UYGULANABİLİRLİK BİLDİRİĞİ Rev.00 20.02.2017
CUSTOMS AND FOREIGN TRADE OPERATIONS AND THE ELECTRONIC INFORMATION ASSETS OF THE ACTIVITIES SUCH AS LOGISTICS, STORAGE, ACCOUNTING, FINANCE, AND INFORMATION PROCESSING RELATED TO THESE OPERATIONS AND THE INFORMATION SECURITY USED TO PROTECT THESE ASSETS. STATEMENT OF APPLICABILITY Rev.00 20.02.2017
 Sertifika No. / Certificate No.: 1870012
 De Belgelendirme Tarihi / Issue Certification Date: 04.01.2018
 Sertifika Tarihi / Date of Certificate: 03.02.2021
 İnceleme Tarihi / Audit Date: 03.02.2021
 Belgelendirme Periyodu / Certification Period: 3 Yıllık / Years
 İstanbul, 04.01.2020 (Rev.02)
 Bu belge, belgelenen işletmenin, belgelenen ve belgelendirme kapsamına giren diğer işleri kapsayan faaliyet alanlarında ilgili alanlardaki gerekliliklere, standartlara ve diğer şartlara uyumunu göstermektedir. İşletmenin bu belgeyi kullanması, belgelenen işleri kapsayan faaliyet alanlarında ilgili alanlardaki gerekliliklere, standartlara ve diğer şartlara uyumunu göstermektedir. İşletmenin bu belgeyi kullanması, belgelenen işleri kapsayan faaliyet alanlarında ilgili alanlardaki gerekliliklere, standartlara ve diğer şartlara uyumunu göstermektedir. İşletmenin bu belgeyi kullanması, belgelenen işleri kapsayan faaliyet alanlarında ilgili alanlardaki gerekliliklere, standartlara ve diğer şartlara uyumunu göstermektedir.
 BELGELENDİRME MERKEZİ BAĞLARI
 TÜRKİYE
 BELGELENDİRME MERKEZİ BAĞLARI
 TÜRKİYE
 BELGELENDİRME MERKEZİ BAĞLARI
 TÜRKİYE

UNICERT
ENERGY MANAGEMENT SYSTEM CERTIFICATE
 Universal GmbH
 This certificate is granted to the organization,
SARAY DOKUM VE MADENİ AKŞAM SANAYİ TURİZM AS.
 Vekilli Sanayi Bölgesi Çekirgeköy Tekirdağ/TURKEY
 by review of SA-14752 numbered report for the scope
EXTRUSION, ANODIZATION AND POWDER COATING OF ALUMINUM PRODUCTS, MANUFACTURE OF PVC PROFILE SYSTEMS AND COMPOSITE PANELS
 to certify that an energy management system in accordance with standard's clauses is established and being implemented
DIN EN ISO 50001:2011
 Certificate No.: ENMS 1119 006456
 Original Certification Date: 06.11.2019
 Issue / Revised Date: 30.09.2020
 Expiry Date: 05.11.2021
 Certification Period: 3 years (2+year)
 İstanbul, 04.01.2020 (Rev.02)
 BELGELENDİRME MERKEZİ BAĞLARI
 TÜRKİYE
 BELGELENDİRME MERKEZİ BAĞLARI
 TÜRKİYE
 BELGELENDİRME MERKEZİ BAĞLARI
 TÜRKİYE

CERTIFICATE
 for a COATING APPLICATOR
QUALIFON
 SEASIDE
 hereby authorizes
Saray Dokum ve Madeni Akşam Sanayi Turizm A.Ş.
 Bağlar Mahallesi Osmangazi Caddesi No: 89
 34209 Güneşli / İstanbul
 Turkey
 to use the quality label in conformity with the QUALIFON 2021 Specifications, applicable from 1 January 2021
 Licence No.: 1402
 Date of Granting: 01.04.2009
 Valid until: 31.12.2021
 Zürich, 1 January 2021
 QUALIFON
 M. C. Panam
 Mohamed C. Panam
 President
 S. C. C. Fared
 Managing Director
 QUALIFON | 1000 Avenue des Alpes, 1000 Lausanne | www.qualifon.ch

СИСТЕМА СЕРТИФИКАЦИИ ГОСТ Р
 ФЕДЕРАЛЬНОЕ АГЕНТСТВО ПО ТЕХНИЧЕСКОМУ РЕГУЛИРОВАНИЮ И МЕТРОЛОГИИ
СЕРТИФИКАТ СООТВЕТСТВИЯ
 № РОСС ТР.АК.010.0197
 Срок действия с 26.12.2019 по 25.12.2022
 № 0490518
 ОГФАН ПО СЕРТИФИКАЦИИ - Орган по сертификации Общества с ограниченной ответственностью "Сертпротект"
 Место нахождения: 115080, Россия, г. Москва, Сормовский район, ул. Сормовская, в/д. 10, стр. 10, 4-й этаж
 Контактная информация: 8 (495) 790-00-00, 8 (495) 790-00-01, 8 (495) 790-00-02, 8 (495) 790-00-03, 8 (495) 790-00-04, 8 (495) 790-00-05, 8 (495) 790-00-06, 8 (495) 790-00-07, 8 (495) 790-00-08, 8 (495) 790-00-09, 8 (495) 790-00-10, 8 (495) 790-00-11, 8 (495) 790-00-12, 8 (495) 790-00-13, 8 (495) 790-00-14, 8 (495) 790-00-15, 8 (495) 790-00-16, 8 (495) 790-00-17, 8 (495) 790-00-18, 8 (495) 790-00-19, 8 (495) 790-00-20, 8 (495) 790-00-21, 8 (495) 790-00-22, 8 (495) 790-00-23, 8 (495) 790-00-24, 8 (495) 790-00-25, 8 (495) 790-00-26, 8 (495) 790-00-27, 8 (495) 790-00-28, 8 (495) 790-00-29, 8 (495) 790-00-30, 8 (495) 790-00-31, 8 (495) 790-00-32, 8 (495) 790-00-33, 8 (495) 790-00-34, 8 (495) 790-00-35, 8 (495) 790-00-36, 8 (495) 790-00-37, 8 (495) 790-00-38, 8 (495) 790-00-39, 8 (495) 790-00-40, 8 (495) 790-00-41, 8 (495) 790-00-42, 8 (495) 790-00-43, 8 (495) 790-00-44, 8 (495) 790-00-45, 8 (495) 790-00-46, 8 (495) 790-00-47, 8 (495) 790-00-48, 8 (495) 790-00-49, 8 (495) 790-00-50, 8 (495) 790-00-51, 8 (495) 790-00-52, 8 (495) 790-00-53, 8 (495) 790-00-54, 8 (495) 790-00-55, 8 (495) 790-00-56, 8 (495) 790-00-57, 8 (495) 790-00-58, 8 (495) 790-00-59, 8 (495) 790-00-60, 8 (495) 790-00-61, 8 (495) 790-00-62, 8 (495) 790-00-63, 8 (495) 790-00-64, 8 (495) 790-00-65, 8 (495) 790-00-66, 8 (495) 790-00-67, 8 (495) 790-00-68, 8 (495) 790-00-69, 8 (495) 790-00-70, 8 (495) 790-00-71, 8 (495) 790-00-72, 8 (495) 790-00-73, 8 (495) 790-00-74, 8 (495) 790-00-75, 8 (495) 790-00-76, 8 (495) 790-00-77, 8 (495) 790-00-78, 8 (495) 790-00-79, 8 (495) 790-00-80, 8 (495) 790-00-81, 8 (495) 790-00-82, 8 (495) 790-00-83, 8 (495) 790-00-84, 8 (495) 790-00-85, 8 (495) 790-00-86, 8 (495) 790-00-87, 8 (495) 790-00-88, 8 (495) 790-00-89, 8 (495) 790-00-90, 8 (495) 790-00-91, 8 (495) 790-00-92, 8 (495) 790-00-93, 8 (495) 790-00-94, 8 (495) 790-00-95, 8 (495) 790-00-96, 8 (495) 790-00-97, 8 (495) 790-00-98, 8 (495) 790-00-99, 8 (495) 790-01-00
 ОГФАН ПО СЕРТИФИКАЦИИ - Орган по сертификации Общества с ограниченной ответственностью "Сертпротект"
 Место нахождения: 115080, Россия, г. Москва, Сормовский район, ул. Сормовская, в/д. 10, стр. 10, 4-й этаж
 Контактная информация: 8 (495) 790-00-00, 8 (495) 790-00-01, 8 (495) 790-00-02, 8 (495) 790-00-03, 8 (495) 790-00-04, 8 (495) 790-00-05, 8 (495) 790-00-06, 8 (495) 790-00-07, 8 (495) 790-00-08, 8 (495) 790-00-09, 8 (495) 790-00-10, 8 (495) 790-00-11, 8 (495) 790-00-12, 8 (495) 790-00-13, 8 (495) 790-00-14, 8 (495) 790-00-15, 8 (495) 790-00-16, 8 (495) 790-00-17, 8 (495) 790-00-18, 8 (495) 790-00-19, 8 (495) 790-00-20, 8 (495) 790-00-21, 8 (495) 790-00-22, 8 (495) 790-00-23, 8 (495) 790-00-24, 8 (495) 790-00-25, 8 (495) 790-00-26, 8 (495) 790-00-27, 8 (495) 790-00-28, 8 (495) 790-00-29, 8 (495) 790-00-30, 8 (495) 790-00-31, 8 (495) 790-00-32, 8 (495) 790-00-33, 8 (495) 790-00-34, 8 (495) 790-00-35, 8 (495) 790-00-36, 8 (495) 790-00-37, 8 (495) 790-00-38, 8 (495) 790-00-39, 8 (495) 790-00-40, 8 (495) 790-00-41, 8 (495) 790-00-42, 8 (495) 790-00-43, 8 (495) 790-00-44, 8 (495) 790-00-45, 8 (495) 790-00-46, 8 (495) 790-00-47, 8 (495) 790-00-48, 8 (495) 790-00-49, 8 (495) 790-00-50, 8 (495) 790-00-51, 8 (495) 790-00-52, 8 (495) 790-00-53, 8 (495) 790-00-54, 8 (495) 790-00-55, 8 (495) 790-00-56, 8 (495) 790-00-57, 8 (495) 790-00-58, 8 (495) 790-00-59, 8 (495) 790-00-60, 8 (495) 790-00-61, 8 (495) 790-00-62, 8 (495) 790-00-63, 8 (495) 790-00-64, 8 (495) 790-00-65, 8 (495) 790-00-66, 8 (495) 790-00-67, 8 (495) 790-00-68, 8 (495) 790-00-69, 8 (495) 790-00-70, 8 (495) 790-00-71, 8 (495) 790-00-72, 8 (495) 790-00-73, 8 (495) 790-00-74, 8 (495) 790-00-75, 8 (495) 790-00-76, 8 (495) 790-00-77, 8 (495) 790-00-78, 8 (495) 790-00-79, 8 (495) 790-00-80, 8 (495) 790-00-81, 8 (495) 790-00-82, 8 (495) 790-00-83, 8 (495) 790-00-84, 8 (495) 790-00-85, 8 (495) 790-00-86, 8 (495) 790-00-87, 8 (495) 790-00-88, 8 (495) 790-00-89, 8 (495) 790-00-90, 8 (495) 790-00-91, 8 (495) 790-00-92, 8 (495) 790-00-93, 8 (495) 790-00-94, 8 (495) 790-00-95, 8 (495) 790-00-96, 8 (495) 790-00-97, 8 (495) 790-00-98, 8 (495) 790-00-99, 8 (495) 790-01-00
 ОГФАН ПО СЕРТИФИКАЦИИ - Орган по сертификации Общества с ограниченной ответственностью "Сертпротект"
 Место нахождения: 115080, Россия, г. Москва, Сормовский район, ул. Сормовская, в/д. 10, стр. 10, 4-й этаж
 Контактная информация: 8 (495) 790-00-00, 8 (495) 790-00-01, 8 (495) 790-00-02, 8 (495) 790-00-03, 8 (495) 790-00-04, 8 (495) 790-00-05, 8 (495) 790-00-06, 8 (495) 790-00-07, 8 (495) 790-00-08, 8 (495) 790-00-09, 8 (495) 790-00-10, 8 (495) 790-00-11, 8 (495) 790-00-12, 8 (495) 790-00-13, 8 (495) 790-00-14, 8 (495) 790-00-15, 8 (495) 790-00-16, 8 (495) 790-00-17, 8 (495) 790-00-18, 8 (495) 790-00-19, 8 (495) 790-00-20, 8 (495) 790-00-21, 8 (495) 790-00-22, 8 (495) 790-00-23, 8 (495) 790-00-24, 8 (495) 790-00-25, 8 (495) 790-00-26, 8 (495) 790-00-27, 8 (495) 790-00-28, 8 (495) 790-00-29, 8 (495) 790-00-30, 8 (495) 790-00-31, 8 (495) 790-00-32, 8 (495) 790-00-33, 8 (495) 790-00-34, 8 (495) 790-00-35, 8 (495) 790-00-36, 8 (495) 790-00-37, 8 (495) 790-00-38, 8 (495) 790-00-39, 8 (495) 790-00-40, 8 (495) 790-00-41, 8 (495) 790-00-42, 8 (495) 790-00-43, 8 (495) 790-00-44, 8 (495) 790-00-45, 8 (495) 790-00-46, 8 (495) 790-00-47, 8 (495) 790-00-48, 8 (495) 790-00-49, 8 (495) 790-00-50, 8 (495) 790-00-51, 8 (495) 790-00-52, 8 (495) 790-00-53, 8 (495) 790-00-54, 8 (495) 790-00-55, 8 (495) 790-00-56, 8 (495) 790-00-57, 8 (495) 790-00-58, 8 (495) 790-00-59, 8 (495) 790-00-60, 8 (495) 790-00-61, 8 (495) 790-00-62, 8 (495) 790-00-63, 8 (495) 790-00-64, 8 (495) 790-00-65, 8 (495) 790-00-66, 8 (495) 790-00-67, 8 (495) 790-00-68, 8 (495) 790-00-69, 8 (495) 790-00-70, 8 (495) 790-00-71, 8 (495) 790-00-72, 8 (495) 790-00-73, 8 (495) 790-00-74, 8 (495) 790-00-75, 8 (495) 790-00-76, 8 (495) 790-00-77, 8 (495) 790-00-78, 8 (495) 790-00-79, 8 (495) 790-00-80, 8 (495) 790-00-81, 8 (495) 790-00-82, 8 (495) 790-00-83, 8 (495) 790-00-84, 8 (495) 790-00-85, 8 (495) 790-00-86, 8 (495) 790-00-87, 8 (495) 790-00-88, 8 (495) 790-00-89, 8 (495) 790-00-90, 8 (495) 790-00-91, 8 (495) 790-00-92, 8 (495) 790-00-93, 8 (495) 790-00-94, 8 (495) 790-00-95, 8 (495) 790-00-96, 8 (495) 790-00-97, 8 (495) 790-00-98, 8 (495) 790-00-99, 8 (495) 790-01-00
 ОГФАН ПО СЕРТИФИКАЦИИ - Орган по сертификации Общества с ограниченной ответственностью "Сертпротект"
 Место нахождения: 115080, Россия, г. Москва, Сормовский район, ул. Сормовская, в/д. 10, стр. 10, 4-й этаж
 Контактная информация: 8 (495) 790-00-00, 8 (495) 790-00-01, 8 (495) 790-00-02, 8 (495) 790-00-03, 8 (495) 790-00-04, 8 (495) 790-00-05, 8 (495) 790-00-06, 8 (495) 790-00-07, 8 (495) 790-00-08, 8 (495) 790-00-09, 8 (495) 790-00-10, 8 (495) 790-00-11, 8 (495) 790-00-12, 8 (495) 790-00-13, 8 (495) 790-00-14, 8 (495) 790-00-15, 8 (495) 790-00-16, 8 (495) 790-00-17, 8 (495) 790-00-18, 8 (495) 790-00-19, 8 (495) 790-00-20, 8 (495) 790-00-21, 8 (495) 790-00-22, 8 (495) 790-00-23, 8 (495) 790-00-24, 8 (495) 790-00-25, 8 (495) 790-00-26, 8 (495) 790-00-27, 8 (495) 790-00-28, 8 (495) 790-00-29, 8 (495) 790-00-30, 8 (495) 790-00-31, 8 (495) 790-00-32, 8 (495) 790-00-33, 8 (495) 790-00-34, 8 (495) 790-00-35, 8 (495) 790-00-36, 8 (495) 790-00-37, 8 (495) 790-00-38, 8 (495) 790-00-39, 8 (495) 790-00-40, 8 (495) 790-00-41, 8 (495) 790-00-42, 8 (495) 790-00-43, 8 (495) 790-00-44, 8 (495) 790-00-45, 8 (495) 790-00-46, 8 (495) 790-00-47, 8 (495) 790-00-48, 8 (495) 790-00-49, 8 (495) 790-00-50, 8 (495) 790-00-51, 8 (495) 790-00-52, 8 (495) 790-00-53, 8 (495) 790-00-54, 8 (495) 790-00-55, 8 (495) 790-00-56, 8 (495) 790-00-57, 8 (495) 790-00-58, 8 (495) 790-00-59, 8 (495) 790-00-60, 8 (495) 790-00-61, 8 (495) 790-00-62, 8 (495) 790-00-63, 8 (495) 790-00-64, 8 (495) 790-00-65, 8 (495) 790-00-66, 8 (495) 790-00-67, 8 (495) 790-00-68, 8 (495) 790-00-69, 8 (495) 790-00-70, 8 (495) 790-00-71, 8 (495) 790-00-72, 8 (495) 790-00-73, 8 (495) 790-00-74, 8 (495) 790-00-75, 8 (495) 790-00-76, 8 (495) 790-00-77, 8 (495) 790-00-78, 8 (495) 790-00-79, 8 (495) 790-00-80, 8 (495) 790-00-81, 8 (495) 790-00-82, 8 (495) 790-00-83, 8 (495) 790-00-84, 8 (495) 790-00-85, 8 (495) 790-00-86, 8 (495) 790-00-87, 8 (495) 790-00-88, 8 (495) 790-00-89, 8 (495) 790-00-90, 8 (495) 790-00-91, 8 (495) 790-00-92, 8 (495) 790-00-93, 8 (495) 790-00-94, 8 (495) 790-00-95, 8 (495) 790-00-96, 8 (495) 790-00-97, 8 (495) 790-00-98, 8 (495) 790-00-99, 8 (495) 790-01-00
 ОГФАН ПО СЕРТИФИКАЦИИ - Орган по сертификации Общества с ограниченной ответственностью "Сертпротект"
 Место нахождения: 115080, Россия, г. Москва, Сормовский район, ул. Сормовская, в/д. 10, стр. 10, 4-й этаж
 Контактная информация: 8 (495) 790-00-00, 8 (495) 790-00-01, 8 (495) 790-00-02, 8 (495) 790-00-03, 8 (495) 790-00-04, 8 (495) 790-00-05, 8 (495) 790-00-06, 8 (495) 790-00-07, 8 (495) 790-00-08, 8 (495) 790-00-09, 8 (495) 790-00-10, 8 (495) 790-00-11, 8 (495) 790-00-12, 8 (495) 790-00-13, 8 (495) 790-00-14, 8 (495) 790-00-15, 8 (495) 790-00-16, 8 (495) 790-00-17, 8 (495) 790-00-18, 8 (495) 790-00-19, 8 (495) 790-00-20, 8 (495) 790-00-21, 8 (495) 790-00-22, 8 (495) 790-00-23, 8 (495) 790-00-24, 8 (495) 790-00-25, 8 (495) 790-00-26, 8 (495) 790-00-27, 8 (495) 790-00-28, 8 (495) 790-00-29, 8 (495) 790-00-30, 8 (495) 790-00-31, 8 (495) 790-00-32, 8 (495) 790-00-33, 8 (495) 790-00-34, 8 (495) 790-00-35, 8 (495) 790-00-36, 8 (495) 790-00-37, 8 (495) 790-00-38, 8 (495) 790-00-39, 8 (495) 790-00-40, 8 (495) 790-00-41, 8 (495) 790-00-42, 8 (495) 790-00-43, 8 (495) 790-00-44, 8 (495) 790-00-45, 8 (495) 790-00-46, 8 (495) 790-00-47, 8 (495) 790-00-48, 8 (495) 790-00-49, 8 (495) 790-00-50, 8 (495) 790-00-51, 8 (495) 790-00-52, 8 (495) 790-00-53, 8 (495) 790-00-54, 8 (495) 790-00-55, 8 (495) 790-00-56, 8 (495) 790-00-57, 8 (495) 790-00-58, 8 (495) 790-00-59, 8 (495) 790-00-60, 8 (495) 790-00-61, 8 (495) 790-00-62, 8 (495) 790-00-63, 8 (495) 790-00-64, 8 (495) 790-00-65, 8 (495) 790-00-66, 8 (495) 790-00-67, 8 (495) 790-00-68, 8 (495) 790-00-69, 8 (495) 790-00-70, 8 (495) 790-00-71, 8 (495) 790-00-72, 8 (495) 790-00-73, 8 (495) 790-00-74, 8 (495) 790-00-75, 8 (495) 790-00-76, 8 (495) 790-00-77, 8 (495) 790-00-78, 8 (495) 790-00-79, 8 (495) 790-00-80, 8 (495) 790-00-81, 8 (495) 790-00-82, 8 (495) 790-00-83, 8 (495) 790-00-84, 8 (495) 790-00-85, 8 (495) 790-00-86, 8 (495) 790-00-87, 8 (495) 790-00-88, 8 (495) 790-00-89, 8 (495) 790-00-90, 8 (495) 790-00-91, 8 (495) 790-00-92, 8 (495) 790-00-93, 8 (495) 790-00-94, 8 (495) 790-00-95, 8 (495) 790-00-96, 8 (495) 790-00-97, 8 (495) 790-00-98, 8 (495) 790-00-99, 8 (495) 790-01-00
 ОГФАН ПО СЕРТИФИКАЦИИ - Орган по сертификации Общества с ограниченной ответственностью "Сертпротект"
 Место нахождения: 115080, Россия, г. Москва, Сормовский район, ул. Сормовская, в/д. 10, стр.

LEED SERTİFİKALARI

LEED CERTIFICATES

EPD BELGESİ

ÇEVRE DOSTU ÜRÜNLER!

EPD çevre dostu ürünlerdir. Her türlü bina için en uygun çözümleri sunar. Çevre dostu ürünlerdir. Her türlü bina için en uygun çözümleri sunar.

KASTAMONU

EPD BELGESİ

ENVIRONMENTAL PRODUCT DECLARATION

ICDLI

CERTIFICATE

We confirm that the ICDLI client member:

Gentas Group

was engaged in the compilation of the Environmental Product Declaration (EPD) for HPL, This as per ISO 14025 and EN 15804

EPD

ENVIRONMENTAL PRODUCT DECLARATION

ICDLI

CERTIFICATE

We confirm that the ICDLI client member:

Gentas Group

was engaged in the compilation of the Environmental Product Declaration (EPD) for HPL, This as per ISO 14025 and EN 15804

EPD

ENVIRONMENTAL PRODUCT DECLARATION

ENVIRONMENTAL PRODUCT DECLARATION
as per ISO 14025 and EN 15804

Programme leader: Institut Bauen und Umwelt e.V. (IBU)

Publication: 13.09.2021

Door and window handles
ARGE, European Federation of Associations of Lock and Builders Hardware Manufacturers

EPD

ENVIRONMENTAL PRODUCT DECLARATION

UMWELT-PRODUKTDOKUMENTATION
nach ISO 14025 und EN 15804

Programmierte: Institut Bauen und Umwelt e.V. (IBU)

Publikation: 13.09.2021

Tür- und Fenstergriffe
ARGE, Arbeitsgemeinschaft der Verbände der Europäischen Schloss- und Beschlagindustrie

EPD

ENVIRONMENTAL PRODUCT DECLARATION

kastamonu

Melamine Faced MDF

ENVIRONMENTAL PRODUCT DECLARATION

In accordance with ISO 14025 and EN 15804:2012+A2:2019

EPD

ENVIRONMENTAL PRODUCT DECLARATION

kastamonu

MDF
Medium Density Fibreboard

ENVIRONMENTAL PRODUCT DECLARATION

In accordance with ISO 14025 and EN 15804:2012+A2:2019

EPD

ENVIRONMENTAL PRODUCT DECLARATION

EPD Environmental Product Declaration

In accordance with ISO 14025 and EN 15804:2012+A2:2019

Class 1 Powder Coating

EPD

ENVIRONMENTAL PRODUCT DECLARATION

EPD Environmental Product Declaration

In accordance with ISO 14025 and EN 15804:2012+A2:2019

Class 2 Powder Coating

EPD

ENVIRONMENTAL PRODUCT DECLARATION

EPD Environmental Product Declaration

In accordance with ISO 14025 and EN 15804:2012+A2:2019

Class 3 Powder Coating

EPD

ENVIRONMENTAL PRODUCT DECLARATION

SARAY ENVIRONMENTAL PRODUCT DECLARATION

In accordance with ISO 14025 and EN 15804:2012+A2:2019 for **Coated Aluminium Profiles**

EPD

ENVIRONMENTAL PRODUCT DECLARATION

SARAY ENVIRONMENTAL PRODUCT DECLARATION

In accordance with ISO 14025 and EN 15804:2012+A2:2019 for **Aluminium Profiles**

EPD

ENVIRONMENTAL PRODUCT DECLARATION

kastamonu

High Gloss Panel (MDF Based)

ENVIRONMENTAL PRODUCT DECLARATION

In accordance with ISO 14025 and EN 15804:2012+A2:2019

EPD

ENVIRONMENTAL PRODUCT DECLARATION

GLOBAL REFERANSLAR



GLOBAL REFERANCES

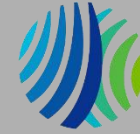

EMAAR OFİS BLOĞU PROJELERİMİZ

EMAAR OFFICE BUILDING PROJECTS

neddoffice®
the final touch



Emaar Square SkyView
Roof



Özersoylar / Turkey
Floor 25



Sofra Grup / England
Floor 23-24



CSL Behring / Australia
Floor 22



Redbull / Austria
Floor 20-21



Daiichi - Sankyo / Japan
Floor 19



Statkraft / Norway
Floor 18



ISS / Denmark
Floor 14



Johnson Control (P&G) / USA
Floor 12



FIBA Group
Floor 11



CMA CGM / USA
Floor 9-10



CEVA Logistics / USA
Floor 6-7-8



Petrol Ofisi / Holland
Floor 2-3-4



Emaar Square Central Office
Floor 1



PROJELER (Emaar)

PROJECTS



Emaar Square
Genel Müdürlük Ofisi
Emaar Square
Headquarters

Yer/Location: Emaar Ofis Bloğu
Alan/Area: 3600 m²
Yıl/Year: 2017

- ✓ trenta th + Karolaj
- ✓ trenta sistem kapı /trenta system door



PROJELER (Emaar)

PROJECTS



Emaar Square
Genel Müdürlük Ofisi
Emaar Square
Headquarters

Yer/Location: Emaar Ofis Bloğu
Alan/Area: 3600 m²
Yıl/Year: 2017

- ✓ trenta th + Karolaj
- ✓ trenta sistem kapı /trenta system door



PROJELER (Emaar)

PROJECTS



Emaar Square
Genel Müdürlük Ofisi
Emaar Square
Headquarters

Yer/Location: Emaar Ofis Bloğu
Alan/Area: 3600 m²
Yıl/Year: 2017

- ✓ trenta th + Karolaj
- ✓ trenta sistem kapı /trenta system door



PROJELER (Emaar)

PROJECTS



Emaar Square
Genel Müdürlük Ofisi
Emaar Square
Headquarters

Yer/Location: Emaar Ofis Bloğu
Alan/Area: 3600 m²
Yıl/Year: 2017

- ✓ trenta th + Karolaj
- ✓ trenta sistem kapı /trenta system door



PROJELER (Emaar)

PROJECTS



Emaar Square
Genel Müdürlük Ofisi
Emaar Square
Headquarters

Yer/Location: Emaar Ofis Bloğu
Alan/Area: 3600 m²
Yıl/Year: 2017

- ✓ trenta th + Karolaj
- ✓ trenta sistem kapı /trenta system door



PROJELER (Emaar)

PROJECTS



Emaar Square
Genel Müdürlük Ofisi
Emaar Square
Headquarters

Yer/Location: Emaar Ofis Bloğu
Alan/Area: 3600 m²
Yıl/Year: 2017

- ✓ trenta th + Karolaj
- ✓ trenta sistem kapı /trenta system door



PROJELER (Emaar)

PROJECTS



Emaar Square
Genel Müdürlük Ofisi
Emaar Square
Headquarters

Yer/Location: Emaar Ofis Bloğu
Alan/Area: 3600 m²
Yıl/Year: 2017

- ✓ trenta th + Karolaj
- ✓ trenta sistem kapı /trenta system door



PROJELER (Emaar)

PROJECTS



Emaar Square
Genel Müdürlük Ofisi
Emaar Square
Headquarters

Yer/Location: Emaar Ofis Bloğu
Alan/Area: 3600 m²
Yıl/Year: 2017

✓ trenta th + Karolaj

✓ trenta sistem kapı /trenta
system door

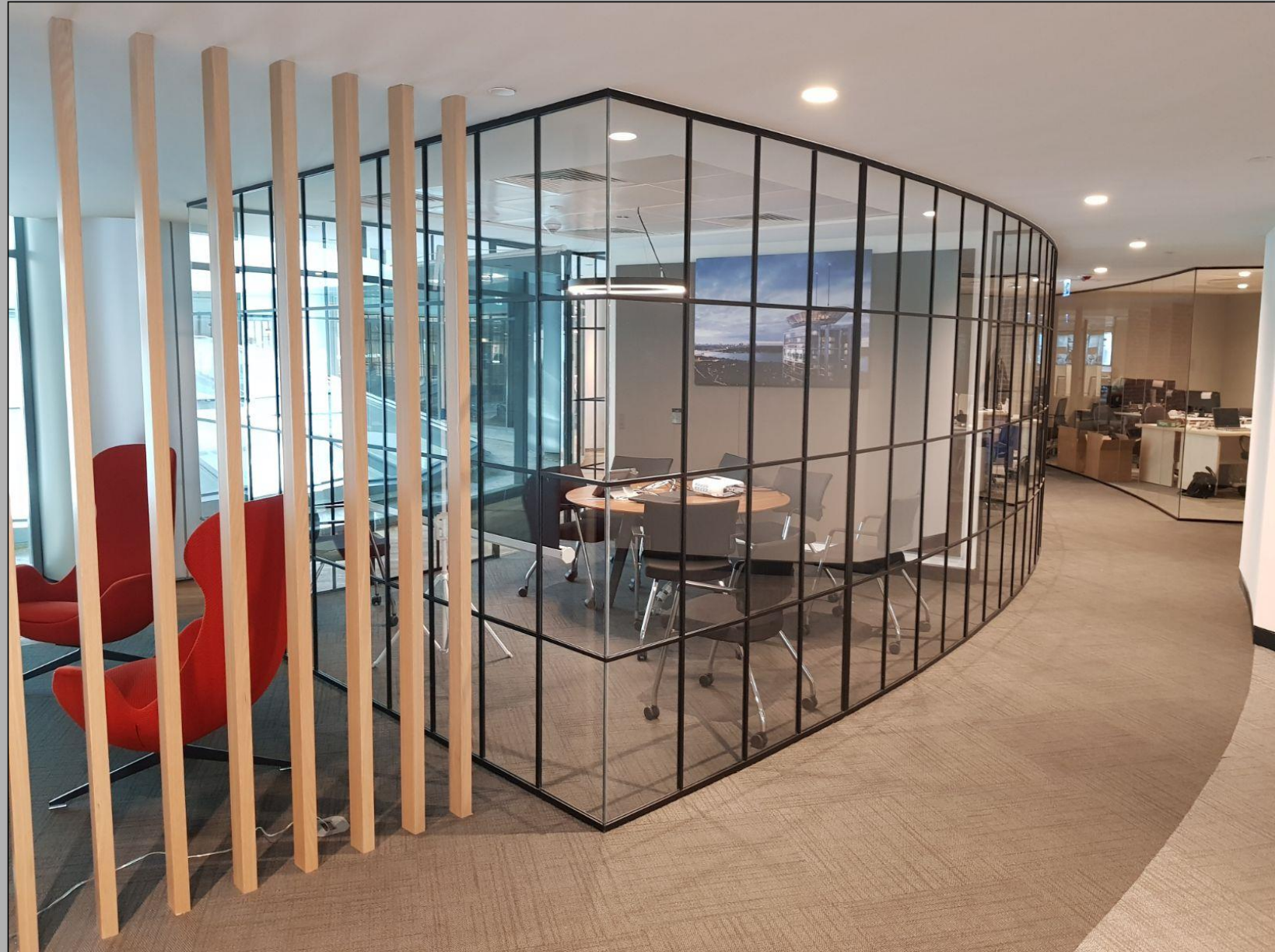

PROJELER (Arvato Bertelsmann)

PROJECTS

arvato

BERTELSMANN

Arvato Bertelsmann
Genel Müdürlük /
Arvato Bertelsmann
Headquarters

Yer/Location: Şişli Plaza
Alan/Area: 3200 m²
Yıl/Year: 2016

- ✓ trenta th 32mm
- ✓ Bombe cam/Curved Glass
- ✓ trenta sistem kapı /trenta system door



PROJELER (Arvato Bertelsmann)

PROJECTS

arvato

BERTELSMANN

Arvato Bertelsmann
Genel Müdürlük /
Arvato Bertelsmann
Headquarters

Yer/Location: Şişli Plaza
Alan/Area: 3200 m²
Yıl/Year: 2016

- ✓ trenta th 32mm
- ✓ Bombe cam/Curved Glass
- ✓ trenta sistem kapı /trenta system door

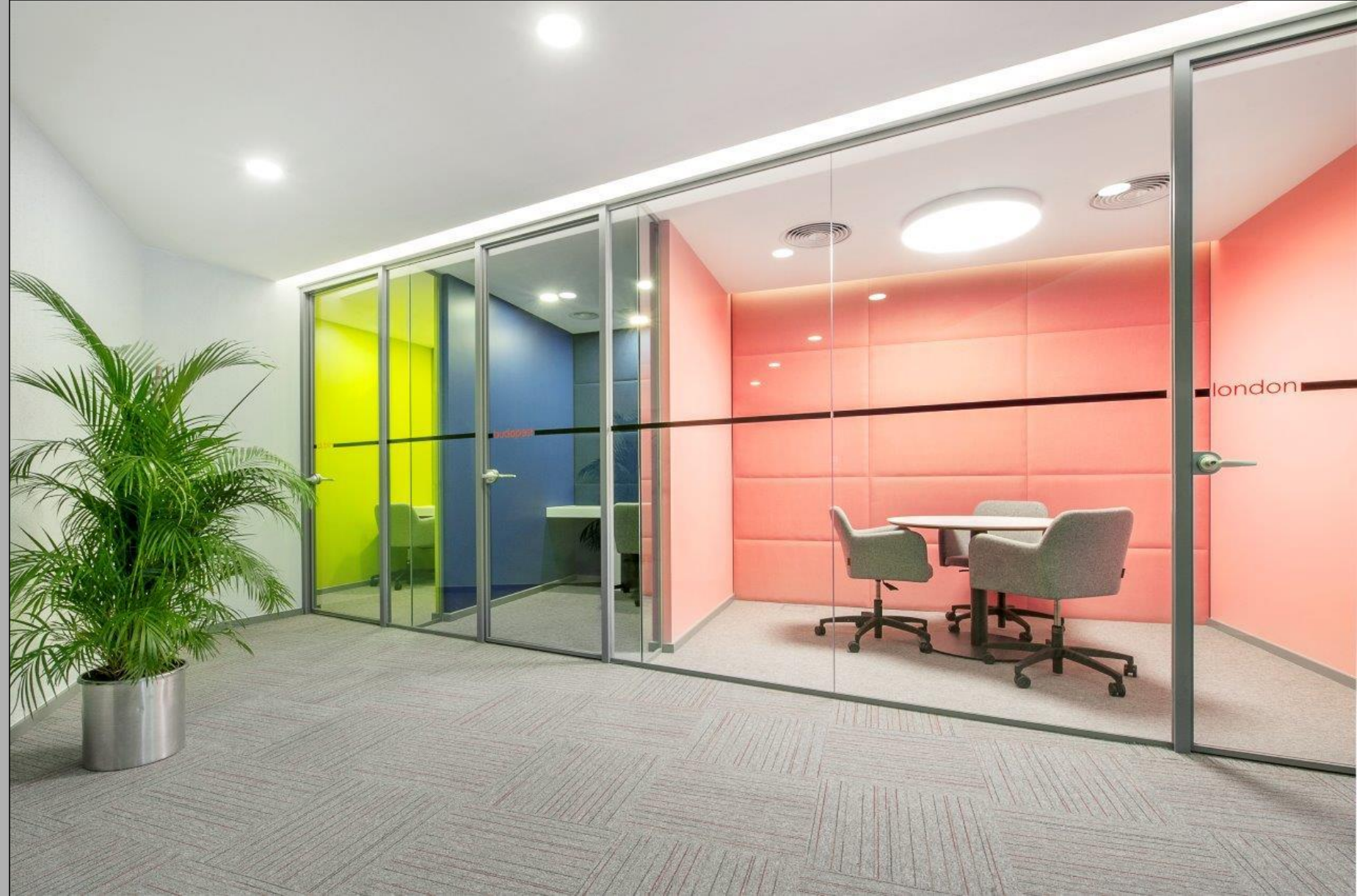

PROJELER (Arvato Bertelsmann)

PROJECTS

arvato

BERTELSMANN

Arvato Bertelsmann
Genel Müdürlük /
Arvato Bertelsmann
Headquarters

Yer/Location: Şişli Plaza
Alan/Area: 3200 m²
Yıl/Year: 2016

- ✓ trenta th 32mm
- ✓ Bombe cam/Curved Glass
- ✓ trenta sistem kapı /trenta system door



PROJELER (Arvato Bertelsmann)

PROJECTS

arvato

BERTELSMANN

Arvato Bertelsmann
Genel Müdürlük /
Arvato Bertelsmann
Headquarters

Yer/Location: Şişli Plaza
Alan/Area: 3200 m²
Yıl/Year: 2016

- ✓ trenta th 32mm
- ✓ Bombe cam/Curved Glass
- ✓ trenta sistem kapı /trenta system door



PROJELER (Arvato Bertelsmann)

PROJECTS

arvato

BERTELSMANN

Arvato Bertelsmann
Genel Müdürlük /
Arvato Bertelsmann
Headquarters

Yer/Location: Şişli Plaza
Alan/Area: 3200 m²
Yıl/Year: 2016

- ✓ trenta th 32mm
- ✓ Bombe cam/Curved Glass
- ✓ trenta sistem kapı /trenta system door



PROJELER (HP Genel Merkez)

PROJECTS



HP Genel Merkez/
HP Headquarters

Yer/Location: Ümraniye Akkom
Plaza

Alan/Area: 400 m²

Yıl/Year: 2015

✓ trenta th 32mm

✓ trenta sistem kapı /trenta
system door



PROJELER (HP Genel Merkez)

PROJECTS



HP Genel Merkez/
HP Headquarters

Yer/Location: Ümraniye Akkom
Plaza

Alan/Area: 400 m²

Yıl/Year: 2015

✓ trenta th 32mm

✓ trenta sistem kapı /trenta
system door



PROJELER (Daiichi)

PROJECTS



Daiichi

Yer/Location: Emaar Ofis Bloğu

Alan/Area: 600 m²

Yil/Year: 2020

✓ trenta th / dg

✓ trenta sistem kapı / trenta
system door



PROJELER (Daiichi)

PROJECTS



Daiichi

Yer/Location: Emaar Ofis Bloğu

Alan/Area: 600 m²

Yil/Year: 2020

✓ trenta th / dg

✓ trenta sistem kapı / trenta
system door



PROJELER (Daiichi)

PROJECTS



Daiichi

Yer/Location: Emaar Ofis Blođu

Alan/Area: 600 m²

Yil/Year: 2020

✓ trenta th / dg

✓ trenta sistem kapı / trenta
system door



PROJELER (Daiichi)

PROJECTS



Daiichi

Yer/Location: Emaar Ofis Bloğu

Alan/Area: 600 m²

Yil/Year: 2020

✓ trenta th / dg

✓ trenta sistem kapı / trenta
system door



PROJELER (Redbull)

PROJECTS



Redbull

Yer/Location: Emaar Ofis Blođu

Alan/Area: 2800 m²

Yıl/Year: 2020

✓ trenta th

✓ trenta sistem kapı /trenta
system door



PROJELER (Redbull)

PROJECTS



Redbull

Yer/Location: Emaar Ofis Blođu

Alan/Area: 2800 m²

Yıl/Year: 2020

✓ trenta th

✓ trenta sistem kapı /trenta
system door



PROJELER (Redbull)

PROJECTS



Redbull

Yer/Location: Emaar Ofis Bloğu

Alan/Area: 2800 m²

Yıl/Year: 2020

✓ trenta th

✓ trenta sistem kapı /trenta
system door

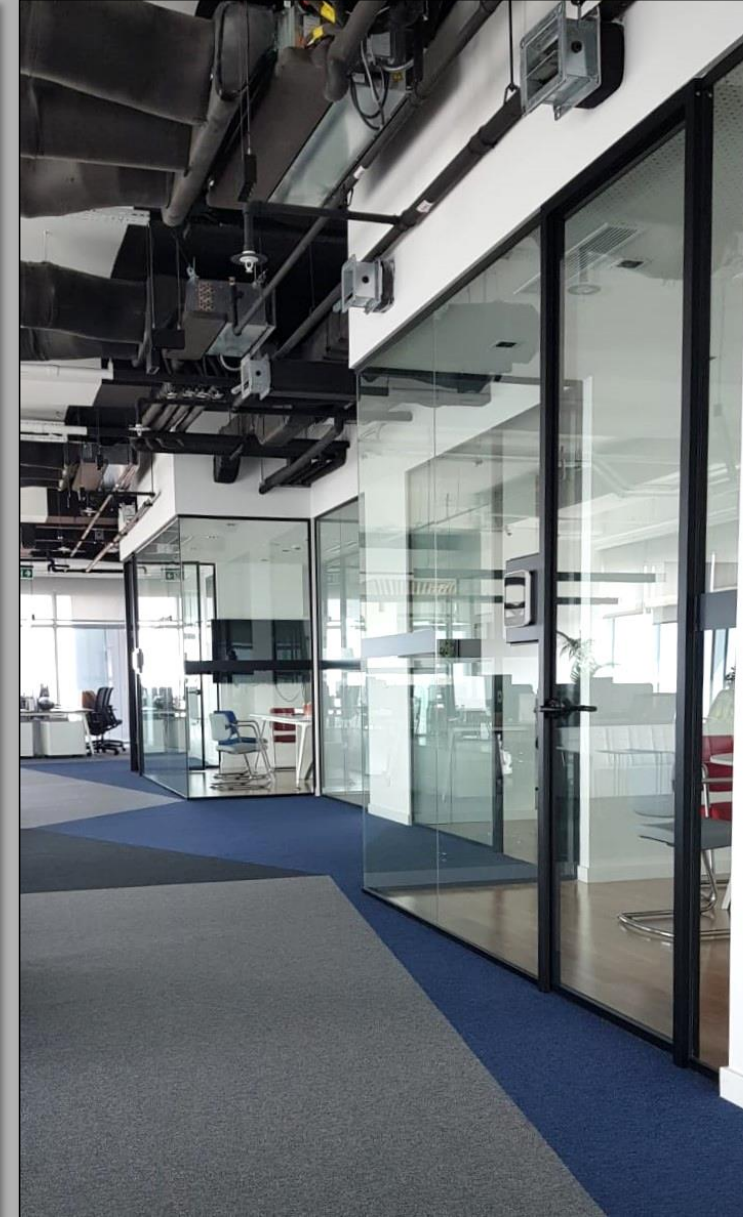

PROJELER (Redbull)

PROJECTS



Redbull

Yer/Location: Emaar Ofis Blođu

Alan/Area: 2800 m²

Yıl/Year: 2020

✓ trenta th

✓ trenta sistem kapı /trenta
system door



PROJELER (ING Bank Orange+Lab)

PROJECTS



ING Bank Orange+LAB

Yer/Location: Maslak
Alan/Area: 2500 m²
Yil/Year: 2016

- ✓ trenta th + Karolaj
- ✓ trenta sistem kapı /trenta system door



PROJELER (ING Bank Orange+Lab)

PROJECTS



ING Bank Orange+LAB

Yer/Location: Maslak
Alan/Area: 2500 m²
Yil/Year: 2016

- ✓ trenta th + Karolaj
- ✓ trenta sistem kapı /trenta system door



PROJELER (Maersk Denizcilik Genel Müdürlüğü)

PROJECTS



Maersk Denizcilik
Genel Müdürlüğü/
Maersk Headquarters

Yer/Location: Ümraniye
Akkom Plaza
Alan/Area: 1500 m²
Yıl/Year: 2019

- ✓ trenta th
- ✓ trenta sistem kapı /trenta system door



PROJELER (Maersk Denizcilik Genel Müdürlüğü)

PROJECTS



MAERSK

Maersk Denizcilik
Genel Müdürlüğü/
Maersk Headquarters

Yer/Location: Ümraniye
Akkom Plaza
Alan/Area: 1500 m²
Yıl/Year: 2019

- ✓ trenta th
- ✓ trenta sistem kapı /trenta system door



PROJELER (CSL Behring)

PROJECTS

CSL Behring

Biotherapies for Life™

CSL Behring
Genel Müdürlük/
CSL Behring Headquarters

Yer/Location: Emaar Ofis
Bloğu
Alan/Area: 700 m²
Yıl/Year: 2020

- ✓ trenta th / dg + Karolaj
- ✓ trenta sistem kapı /trenta system door



PROJELER (CSL Behring)

PROJECTS

CSL Behring

Biotherapies for Life™

CSL Behring
Genel Müdürlük/
CSL Behring Headquarters

Yer/Location: Emaar Ofis
Bloğu
Alan/Area: 700 m²
Yıl/Year: 2020

- ✓ trenta th / dg + Karolaj
- ✓ trenta sistem kapı /trenta system door



PROJELER (CSL Behring)

PROJECTS

CSL Behring

Biotherapies for Life™

CSL Behring
Genel Müdürlük/
CSL Behring Headquarters

Yer/Location: Emaar Ofis
Bloğu
Alan/Area: 700 m²
Yıl/Year: 2020

- ✓ trenta th / dg + Karolaj
- ✓ trenta sistem kapı /trenta system door



PROJELER (AvivaSA/UniCO)

neddoffice®
the final touch

PROJECTS

AVIVA SA

AvivaSA Genel Müdürlük
AvivaSA Headquarters

Yer/Location: Göztepe Nidakule
Alan/Area: 1800 m²
Yıl/Year: 2015

✓ trenta th

✓ trenta sistem kapı /trenta system door



PROJELER (AvivaSA)

PROJECTS



AvivaSA Genel Müdürlük
AvivaSA Headquarters

Yer/Location: Göztepe Nidakule
Alan/Area: 1800 m²
Yıl/Year: 2015

✓ trenta th

✓ trenta sistem kapı /trenta system door



PROJELER (AvivaSA)

PROJECTS



AvivaSA Genel Müdürlük
AvivaSA Headquarters

Yer/Location: Göztepe Nidakule
Alan/Area: 1800 m²
Yıl/Year: 2015

✓ trenta th

✓ trenta sistem kapı /trenta system
door

neddoffice®
the final touch

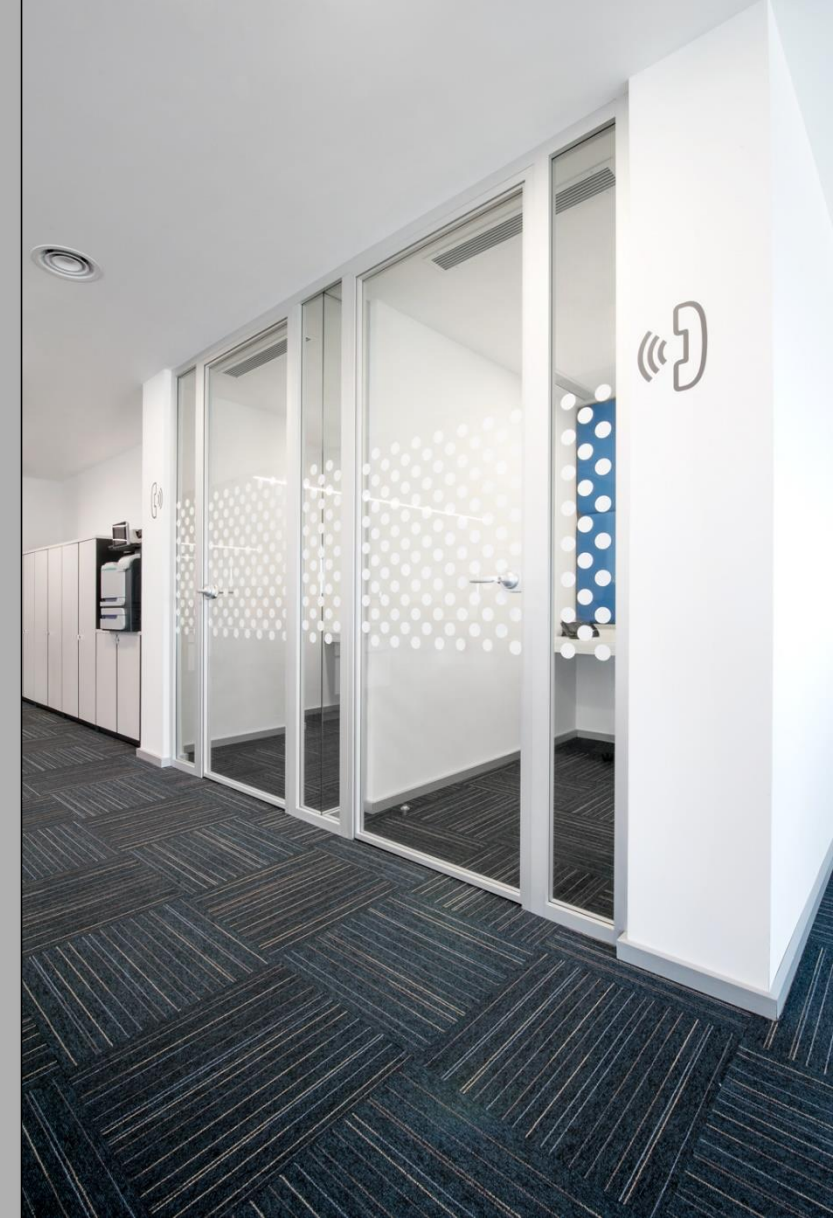

PROJELER (AkçanSA)

neddoffice®
the final touch

PROJECTS

AKÇANSA

AkçanSA Genel Müdürlük /
AkçanSA Headquarters

Yer/Location: Palladium Tower
Alan/Area: 1848 m²
Yıl/Year: 2019

✓ trenta th

✓ trenta sistem kapı /trenta system door



PROJELER (AkçanSA)

neddoffice®
the final touch

PROJECTS

AKÇANSA

AkçanSA Genel Müdürlük /
AkçanSA Headquarters

Yer/Location: Palladium Tower
Alan/Area: 1848 m²
Yıl/Year: 2019

✓ trenta th

✓ trenta sistem kapı /trenta system
door



PROJELER (AkçanSA)

PROJECTS

AKÇANSA

AkçanSA Genel Müdürlük /
AkçanSA Headquarters

Yer/Location: Palladium Tower
Alan/Area: 1848 m²
Yıl/Year: 2019

✓ trenta th

✓ trenta sistem kapı /trenta system
door



PROJELER (EnerjiSA)

neddoffice®
the final touch

PROJECTS



EnerjiSA Genel Müdürlük /
EnerjiSA Headquarters

Yer/Location: My Office Ataşehir
Alan/Area: 4900 m²
Yıl/Year: 2020

✓ trenta th

✓ trenta sistem kapı /trenta
system door



PROJELER (EnerjiSA)

PROJECTS



EnerjiSA Genel Müdürlük /
EnerjiSA Headquarters

Yer/Location: My Office Ataşehir
Alan/Area: 4900 m²
Yıl/Year: 2020

✓ trenta th

✓ trenta sistem kapı /trenta
system door



PROJELER (EnerjiSA)

PROJECTS



EnerjiSA Genel Müdürlük /
EnerjiSA Headquarters

Yer/Location: My Office Ataşehir
Alan/Area: 4900 m²
Yıl/Year: 2020

✓ trenta th

✓ trenta sistem kapı /trenta
system door



PROJELER (Arçelik)

PROJECTS



Arçelik Sütüce Ofisi/
Arçelik Sütüce Office

Yer/Location: My Office
Ataşehir
Alan/Area: 700 m²
Yıl/Year: 2021

✓ trenta th

✓ trenta sistem kapı /trenta
system door



PROJELER (Arçelik)

neddoffice®
the final touch

PROJECTS

 **arçelik**

Arçelik Sütüce Ofisi/
Arçelik Sütüce Office

Yer/Location: My Office
Ataşehir
Alan/Area: 700 m²
Yıl/Year: 2021

✓ trenta th

✓ trenta sistem kapı /trenta
system door



PROJELER (Arçelik)

PROJECTS



Arçelik Sütüce Ofisi/
Arçelik Sütüce Office

Yer/Location: My Office
Ataşehir
Alan/Area: 700 m²
Yıl/Year: 2021

✓ trenta th

✓ trenta sistem kapı /trenta
system door



PROJELER (Arçelik)

neddoffice®
the final touch

PROJECTS

 **arçelik**

Arçelik Sütluce Ofisi/
Arçelik Sütluce Office

Yer/Location: My Office
Ataşehir
Alan/Area: 700 m²
Yıl/Year: 2021

✓ trenta th

✓ trenta sistem kapı /trenta
system door



PROJELER (Özersoylar)

PROJECTS



Özersoylar
Genel Müdürlüğü/
Özersoylar
Headquarters

Yer/Location: Emaar Ünalán
Alan/Area: 700 m²
Yıl/Year: 2021

- ✓ trenta th / dg
- ✓ Bombe füme cam / Curved smoked glass
- ✓ trenta sistem kapı / trenta system door



PROJELER (Özersoylar)

PROJECTS



Özersoylar
Genel Müdürlüğü/
Özersoylar
Headquarters

Yer/Location: Emaar Ünalán
Alan/Area: 700 m²
Yıl/Year: 2021

- ✓ trenta th / dg
- ✓ Bombe füme cam / Curved smoked glass
- ✓ trenta sistem kapı / trenta system door



PROJELER (Özersoylar)

PROJECTS



Özersoylar
Genel Müdürlüğü/
Özersoylar
Headquarters

Yer/Location: Emaar Ünalán
Alan/Area: 700 m²
Yıl/Year: 2021

- ✓ trenta th / dg
- ✓ Bombe füme cam / Curved smoked glass
- ✓ trenta sistem kapı / trenta system door



PROJELER (Özersoylar)

PROJECTS



Özersoylar
Genel Müdürlüğü/
Özersoylar
Headquarters

Yer/Location: Emaar Ünalán
Alan/Area: 700 m²
Yıl/Year: 2021

- ✓ trenta th / dg
- ✓ Bombe füme cam / Curved smoked glass
- ✓ trenta sistem kapı / trenta system door



PROJELER (Özersoylar)

PROJECTS



Özersoylar
Genel Müdürlüğü/
Özersoylar
Headquarters

Yer/Location: Emaar Ünalán
Alan/Area: 700 m²
Yıl/Year: 2021

- ✓ trenta th / dg
- ✓ Bombe füme cam / Curved smoked glass
- ✓ trenta sistem kapı / trenta system door



PROJELER (Codeway)

PROJECTS



codeway

Codeway
Genel Müdürlüğü /
Codeway
Headquarters

Yer/Location: Ferko Plaza
Alan/Area: 600 m²
Yıl/Year: 2021

- ✓ trenta th
- ✓ Bombe cam / Curved glass
- ✓ trenta sistem kapı / trenta system door



PROJELER (Codeway)

PROJECTS



codeway

Codeway
Genel Müdürlüğü /
Codeway
Headquarters

Yer/Location: Ferko Plaza
Alan/Area: 600 m²
Yıl/Year: 2021

- ✓ trenta th
- ✓ Bombe cam / Curved glass
- ✓ trenta sistem kapı /trenta system door



PROJELER (Codeway)

PROJECTS



codeway

Codeway
Genel Müdürlüğü /
Codeway
Headquarters

Yer/Location: Ferko Plaza
Alan/Area: 600 m²
Yıl/Year: 2021

- ✓ trenta th
- ✓ Bombe cam / Curved glass
- ✓ trenta sistem kapı /trenta system door



PROJELER (Codeway)

PROJECTS



codeway

Codeway
Genel Müdürlüğü /
Codeway
Headquarters

Yer/Location: Ferko Plaza
Alan/Area: 600 m²
Yıl/Year: 2021

- ✓ trenta th
- ✓ Bombe cam / Curved glass
- ✓ trenta sistem kapı / trenta system door



PROJELER (Codeway)

PROJECTS



codeway

Codeway
Genel Müdürlüğü /
Codeway
Headquarters

Yer/Location: Ferko Plaza
Alan/Area: 600 m²
Yıl/Year: 2021

- ✓ trenta th
- ✓ Bombe cam / Curved glass
- ✓ trenta sistem kapı / trenta system door



PROJELER

PROJECTS



Eclips / Maslak



Accor / Ferko

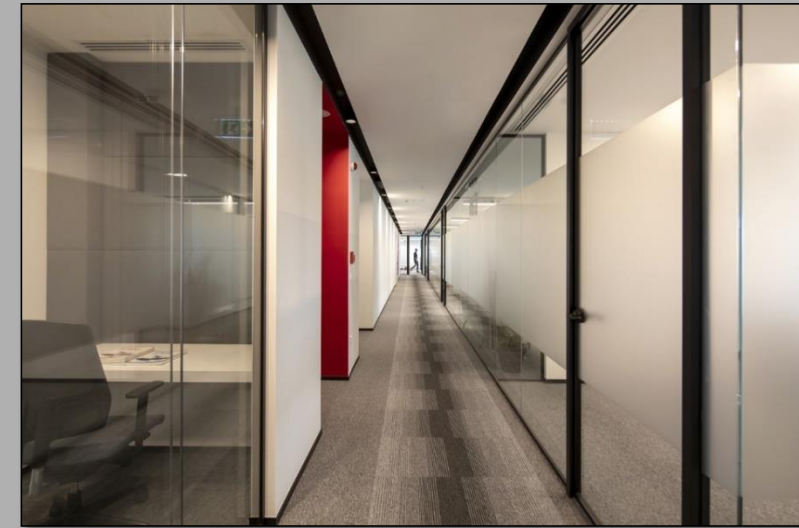

CEVA / Emaar



Eclips / Maslak



BASF / Gebze



CEVA / Emaar

PROJELER

PROJECTS



Demir Hayat Sigorta



ISS / Emaar



Getinge / Allianz Tower



Demir Hayat Sigorta



ISS / Emaar



Getinge / Allianz Tower

PROJELER

PROJECTS

neddoffice®
the final touch



Çağdaş Kışlaoğlu Diş Kliniği / Zorlu Center



Tekfen İnşaat Yönetim Ofisi / Levent



İş Yatırım / İş Kule Levent



Çağdaş Kışlaoğlu Diş Kliniği / Zorlu Center



Tekfen İnşaat Yönetim Ofisi / Levent



İş Yatırım / İş Kule Levent

İLETİŞİM BİLGİLERİ

CONTACTS

Merkez Ofis Adresi / Main Office Adress

Cumhuriyet Mahallesi Yeniyol Sokak No:8 Bomonti Business Center No:51
Kağıthane /İSTANBUL

İmalathane Adresi 1 / Factory Adress 1

Hamidiye Mahallesi Günel Sokak No:21/ A
Kağıthane /İSTANBUL

İmalathane Adresi 2 / Factory Adress 2

Hamidiye Mahallesi Şehit Hasankaya Sokak No:8/A
Kağıthane /İSTANBUL

